

**FLUKE®**

# **Model 77 Series IV**

## Digital Multimeter

Users Manual

PN 2695884

September 2006

© 2006 Fluke Corporation. All rights reserved. Printed in USA

All product names are trademarks of their respective companies.

## Lifetime Limited Warranty

Each Fluke 20, 70, 80, 170 and 180 Series DMM will be free from defects in material and workmanship for its lifetime. As used herein, "lifetime" is defined as seven years after Fluke discontinues manufacturing the product, but the warranty period shall be at least ten years from the date of purchase. This warranty does not cover fuses, disposable batteries, damage from neglect, misuse, contamination, alteration, accident or abnormal conditions of operation or handling, including failures caused by use outside of the product's specifications, or normal wear and tear of mechanical components. This warranty covers the original purchaser only and is not transferable.

For ten years from the date of purchase, this warranty also covers the LCD. Thereafter, for the lifetime of the DMM, Fluke will replace the LCD for a fee based on then current component acquisition costs.

To establish original ownership and prove date of purchase, please complete and return the registration card accompanying the product, or register your product on <http://www.fluke.com>. Fluke will, at its option, repair at no charge, replace or refund the purchase price of a defective product purchased through a Fluke authorized sales outlet and at the applicable international price. Fluke reserves the right to charge for importation costs of repair/replacement parts if the product purchased in one country is sent for repair elsewhere.

If the product is defective, contact your nearest Fluke authorized service center to obtain return authorization information, then send the product to that service center, with a description of the difficulty, postage and insurance prepaid (FOB Destination). Fluke assumes no risk for damage in transit. Fluke will pay return transportation for product repaired or replaced in-warranty. Before making any non-warranty repair, Fluke will estimate cost and obtain authorization, then invoice you for repair and return transportation.

THIS WARRANTY IS YOUR ONLY REMEDY. NO OTHER WARRANTIES, SUCH AS FITNESS FOR A PARTICULAR PURPOSE, ARE EXPRESSED OR IMPLIED. FLUKE SHALL NOT BE LIABLE FOR ANY SPECIAL, INDIRECT, INCIDENTAL OR CONSEQUENTIAL DAMAGES OR LOSSES, INCLUDING LOSS OF DATA, ARISING FROM ANY CAUSE OR THEORY. AUTHORIZED RESELLERS ARE NOT AUTHORIZED TO EXTEND ANY DIFFERENT WARRANTY ON FLUKE'S BEHALF. Since some states do not allow the exclusion or limitation of an implied warranty or of incidental or consequential damages, this limitation of liability may not apply to you. If any provision of this warranty is held invalid or unenforceable by a court or other decision-maker of competent jurisdiction, such holding will not affect the validity or enforceability of any other provision.

Fluke Corporation  
P.O. Box 9090  
Everett, WA 98206-9090  
U.S.A.

Fluke Europe B.V.  
P.O. Box 1186  
5602 BD Eindhoven  
The Netherlands

Visit the Fluke website at: [www.fluke.com](http://www.fluke.com)  
Register your Meter at: [register.fluke.com](http://register.fluke.com)

# Table of Contents















| Title                                 | Page |
|---------------------------------------|------|
| Contacting Fluke .....                | 1    |
| Warning and Caution Statements.....   | 1    |
| Unsafe Voltage .....                  | 1    |
| Test Lead Alert .....                 | 1    |
| Battery Saver (Sleep Mode) .....      | 2    |
| Terminals .....                       | 2    |
| Rotary Switch Positions .....         | 2    |
| Display .....                         | 3    |
| MIN MAX AVG Recording Mode .....      | 4    |
| AutoHOLD Modes.....                   | 4    |
| YELLOW Button .....                   | 4    |
| Display Backlight .....               | 4    |
| Manual Ranging and Autoranging .....  | 5    |
| Power-Up Options .....                | 5    |
| Making Basic Measurements .....       | 6    |
| Measuring AC and DC Voltage .....     | 6    |
| Measuring Resistance .....            | 6    |
| Measuring Capacitance.....            | 6    |
| Testing for Continuity.....           | 7    |
| Testing Diodes.....                   | 7    |
| Measuring AC or DC Current .....      | 8    |
| Measuring Frequency.....              | 8    |
| Using the Bar Graph .....             | 9    |
| Cleaning.....                         | 9    |
| Testing the Fuses .....               | 9    |
| Replacing the Battery and Fuses ..... | 10   |
| Specifications.....                   | 11   |

**⚠ ⚠ Warning. Read before using the Meter**

To avoid possible electrical shock or personal injury, follow these guidelines:

- ⇒ Use the Meter only as specified in this manual or the protection provided by the Meter might be impaired.
- ⇒ Do not use the Meter or test leads if they appear damaged, or if the Meter is not operating properly. If in doubt, have the Meter serviced.
- ⇒ Always use the proper terminals, switch position, and range for measurements.
- ⇒ Verify the Meter's operation by measuring a known voltage.
- ⇒ Do not apply more than the rated voltage, as marked on the Meter, between the terminals or between any terminal and earth ground.
- ⇒ Use caution with voltages above 30 V ac rms, 42 V ac peak, or 60 V dc. These voltages pose a shock hazard.
- ⇒ Disconnect circuit power and discharge all high-voltage capacitors before testing resistance, continuity, diodes, or capacitance.
- ⇒ Do not use the Meter around explosive gas or vapor.
- ⇒ When using the test leads, keep your fingers behind the finger guards.
- ⇒ Remove test leads from the Meter before opening the Meter case or battery door.

**Symbols**

|   |  |   |   |
|---|--|---|---|
|  | AC (Alternating Current)   |  | Fuse  |
|  | DC (Direct Current)  |  | Conforms to European Union directives   |
|  | DC/AC  |  | Canadian Standards Association  |
|  | Earth ground   |  | Double insulated  |
|  | Important Information; see manual  |  | Hazardous Voltage   |
|  | Battery (Low battery when shown on display)  |  | Underwriters Laboratories, Inc.<br>Meter in accordance with IEC 61010-1. 54CJ |
|  | Inspected and licensed by TÜV<br>(Technischer Überwachungs Verein)<br>Product Services |  | Conforms to relevant Australian standards                                     |
|  | VDE (Verband Deutscher Electroniker)   |   |   |

# Model 77 Series IV

## Digital Multimeter

The Fluke **Model 77 Series IV** is a battery-powered, average responding-rms indicating multimeter (hereafter "the Meter"), with a 6000-count, 3 3/4-digit display, and a bar graph.

This meter meets CAT III and CAT IV IEC 61010 standards. The IEC 61010 safety standard defines four measurement categories (CAT I to IV) based on the magnitude of danger from transient impulses. CAT III meters are designed to protect against transients in fixed-equipment installations at the distribution level; CAT IV meters are designed to protect against transients from the primary supply level (overhead or underground utility service).

The Meter measures or tests the following:

- ◆ AC / DC voltage & current
- ◆ Resistance
- ◆ Voltage frequency
- ◆ Diodes
- ◆ Continuity
- ◆ Capacitance

### Contacting Fluke

To contact Fluke, call:

- 1-888-993-5853 in USA
- 1-800-363-5853 in Canada
- +31 402-675-200 in Europe
- +81-3-3434-0181 in Japan
- +65-738-5655 in Singapore
- +1-425-446-5500 from anywhere in the world

Visit Fluke's web site at: [www.fluke.com](http://www.fluke.com)

Register your Meter at: [register.fluke.com](http://register.fluke.com)

### Warning and Caution Statements

A **⚠ Warning** identifies hazardous conditions and actions that could cause bodily harm or death.

A **Caution** identifies conditions and actions that could damage the Meter, the equipment under test, or cause permanent loss of data.

### Unsafe Voltage

To alert you to the presence of a potentially hazardous voltage, when the Meter detects a voltage  $\geq 30$  V or a voltage overload (**OL**), the **⚡** symbol is displayed.

### Test Lead Alert

To remind you to check that the test leads are in the correct terminals, **LEAD** is momentarily displayed when you move the rotary switch *to* or *from* the **mA** or **A** position.

### ⚠ Warning

**Attempting to make a measurement with a test lead in an incorrect terminal might blow a fuse, damage the Meter, and cause serious personal injury.**

### Battery Saver (Sleep Mode)

The Meter enters the "Sleep" mode and blanks out the display if there is no function change or button press for 20 minutes. To disable the Sleep mode, hold down the yellow button while turning the Meter on. The Sleep mode is always disabled in the MIN MAX AVG mode and the AutoHOLD mode.

### Terminals

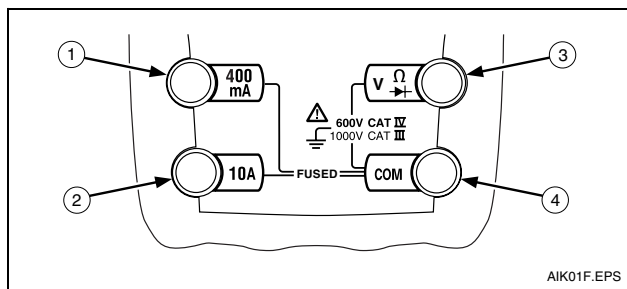

| Item | Description  |
|------|--|
| 1    | Input terminal for AC and DC milliamp measurements to 400 mA.  |
| 2    | Input terminal for AC and DC current measurements to 10 A.   |
| 3    | Input terminal for voltage, continuity, resistance, diode test, capacitance, and frequency measurements. |
| 4    | Common (return) terminal for all measurements.   |

### Rotary Switch Positions

| Switch Position         | Measurement Function   |
|-------------------------|--|
| $\tilde{V}$             | AC voltage from 0.001 to 1000 V.                                 |
| Hz                      | Frequency from 2 Hz to 99.99 kHz.                                |
| $\bar{V}$               | DC voltage from 1 mV to 1000 V.                                  |
| m $\bar{V}$             | DC mV from 0.1 mV to 600 mV.                                     |
| $\Omega$                | Ohms from 0.1 $\Omega$ to 50 M $\Omega$ .                        |
| $\text{---} \text{---}$ | Farads from 1 nF to 9999 $\mu$ F.                                |
| $\text{---} \text{---}$ | Beeper turns on at <25 $\Omega$ and turns off at >250 $\Omega$ . |
| $\text{---} \text{---}$ | Diode test. Displays OL above 2.4 V.                             |
| $\text{---} \sim$       | AC mA from 0.01 mA to 400 mA.                                    |
| <b>mA</b>               | DC mA from 0.01 mA to 400 mA.                                    |
| $\text{---} \text{---}$ | AC A from 0.001 A to 10 A.                                       |
| $\sim \text{A}$         | DC A from 0.001 A to 10 A  |
|                         | >10.00 display flashes.  |
|                         | >20 A, <b>OL</b> is displayed.                                   |

Display

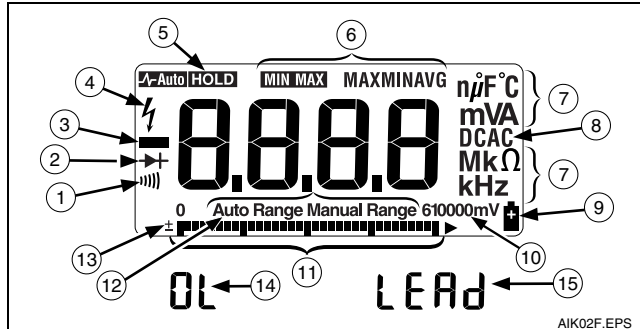

AIK02F.EPS

| No. | Symbol  | Meaning  |
|-----|---|--|
| 1   | )))   | Continuity test.   |
| 2   | ▶ +   | Diode test.  |
| 3   | —   | Negative readings.   |
| 4   | ⚡   | Unsafe voltage. Voltage $\geq 30$ V, or voltage overload (OL)  |
| 5   | <b>HOLD</b>                                       | AutoHOLD is enabled. Display holds present reading until it detects new stable input. Then the Meter beeps and displays new reading. |
| 6   | <b>MIN MAX</b><br><b>MAX , MIN,</b><br><b>AVG</b> | MIN MAX AVG enabled.<br>Maximum, minimum, average, or present reading.   |
| 7   | <b>nF, mVA,</b><br><b>MkΩ, kHz</b>                | Measurement units.   |

| No. | Symbol                                   | Meaning   |
|-----|--|---|
| 8   | <b>DC, AC</b>                            | Direct current, alternating current.  |
| 9   | +  | Low battery. Replace battery.   |
| 10  | <b>610000mV</b>                          | All possible ranges.  |
| 11  | Bar graph                                | Analog display.   |
| 12  | <b>Auto Range</b><br><b>Manual Range</b> | The Meter selects the range with the best resolution.<br>The user selects the range.                                      |
| 13  | $\pm$                                    | Bar graph polarity.   |
| 14  | <b>OL</b>                                | The input out of range.   |
| 15  | <b>LEAD</b>                              | $\Delta$ Test lead alert. Displayed when the rotary switch is moved <i>to or from</i> the <b>mA</b> or <b>A</b> position. |

| Error Messages  |   |
|-----------------|---|
| <b>bAtt</b>     | Replace the battery immediately.  |
| <b>diSC</b>     | In the capacitance function, too much electrical charge is present on the capacitor being tested. |
| <b>EEPr Err</b> | Invalid EEPROM data. Have Meter serviced.   |
| <b>CAL Err</b>  | Invalid calibration data. Calibrate Meter.  |

### **MIN MAX AVG Recording Mode**

The MIN MAX AVG recording mode captures the minimum and maximum input values, and calculates a running average of all readings. When a new high or low is detected, the Meter beeps.

#### *Note*

*For dc functions, accuracy is the specified accuracy of the measurement function  $\pm 12$  counts for changes longer than 275 ms in duration.*

*For ac functions, accuracy is the specified accuracy of the measurement function  $\pm 40$  counts for changes longer than 1.2 s in duration.*

To use MIN MAX AVG recording:

- ⇒ Make sure that the Meter is in the desired measurement function and range. (Autoranging is disabled in the MIN MAX AVG mode.)
- ⇒ Press **MIN MAX** to activate MIN MAX AVG mode. **MIN MAX** and **MAX** light, and the highest reading detected since entering MIN MAX AVG is displayed.
- ⇒ Press **MIN MAX** to step through the low (**MIN**), average (**AVG**), and present readings.
- ⇒ To pause MIN MAX AVG recording without erasing stored values, press **HOLD**. **HOLD** is displayed.  
To resume MIN MAX AVG recording, press **HOLD** again. **HOLD** turns off.
- ⇒ To exit and erase stored readings, press MIN MAX for 1 second or turn the rotary switch.

### **AutoHOLD Modes**

#### **⚠ ⚠ Warning**

**To avoid electric shock, do not use the AutoHOLD mode to determine if a circuit is live. Unstable or noisy readings will not be captured.**

In the AutoHOLD mode, the Meter holds the reading on the display *until* it detects a new stable reading. Then the Meter beeps, and displays the new reading.

- ⇒ Press **HOLD** to activate AutoHOLD. **HOLD** lights.
- ⇒ Press **HOLD** again or turn the rotary switch to resume normal operation.

### **YELLOW Button**

Press the yellow button to select alternate measurement functions on a rotary switch setting, e.g., to select DC mA, DC A, Hz, capacitance, or diode test.

### **Display Backlight**

Press  to toggle the backlight on and off. The backlight automatically turns off after 2 minutes.



### Manual Ranging and Autoranging

The Meter has both Manual range and Autorange modes.

- ⇒ In the Autorange mode, the Meter selects the range with the best resolution.
- ⇒ In the Manual Range mode, you override Autorange and select the range yourself.

When you turn the Meter on, it defaults to Autorange and **Auto Range** is displayed.

1. To enter the Manual Range mode, press **RANGE**. **Manual Range** is displayed.
2. In the Manual Range mode, press **RANGE** to increment the range. After the highest range, the Meter wraps to the lowest range.

*Note*

*You cannot manually change the range in the MIN MAX AVG mode.*





*If you press **RANGE** while in MIN MAX\_AVG, the Meter beeps, indicating an invalid operation, and the range does not change.*

3. To exit Manual Range, press **RANGE** for 1 second or turn the rotary switch.  
The Meter returns to Autorange and **Auto Range** is displayed.

### Power-Up Options

To select a Power-Up Option, hold down the button indicated while turning the Meter on.

Power-Up Options are cancelled when the Meter is turned OFF.

| Button  | Power-Up Options   |
|---|--|
|              | Turns on all display segments when in VAC switch position.   |
|              | Disables beeper. bE E P is displayed when enabled.   |
|              | Enables "Smoothing" mode. 5--- is displayed when enabled.<br>Dampens display fluctuations of rapidly changing inputs by digital filtering.   |
| <br>(YELLOW) | Disables automatic power-down ("Sleep mode"). P o F F is displayed when enabled<br>Sleep mode is also disabled while the Meter is in a MIN MAX AVG Recording mode, or the AutoHOLD mode. |
|              | Disables automatic 2-minute backlight timeout. L o F F is displayed when enabled.  |

### **Making Basic Measurements**

The figures on the following pages show how to make basic measurements.

When connecting the test leads to the circuit or device, connect the common (**COM**) test lead before connecting the live lead; when removing the test leads, remove the live lead before removing the common test lead.

#### **⚠⚠Warning**

**To avoid electric shock or injury, or damage to the Meter, disconnect circuit power and discharge all high-voltage capacitors before testing resistance, continuity, diodes, or capacitance.**

### **Measuring AC and DC Voltage**

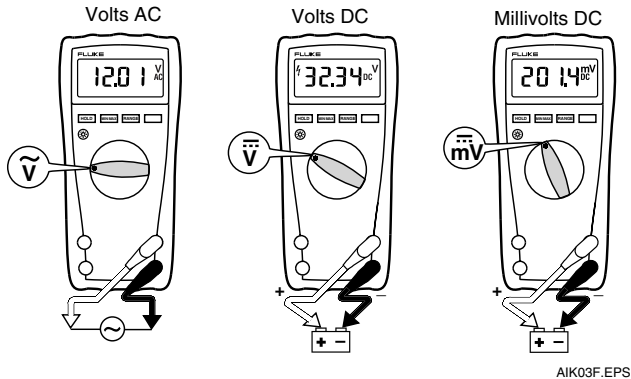

### **Measuring Resistance**

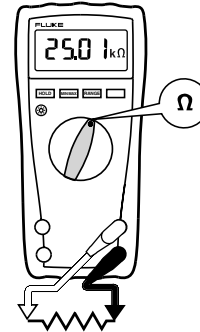

AIK04F.EPS

### **Measuring Capacitance**

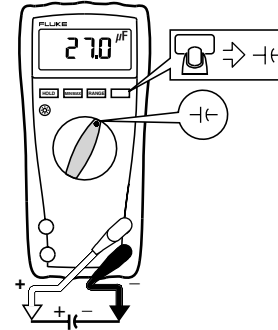

AIK05F.EPS

Testing for Continuity

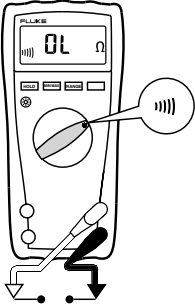
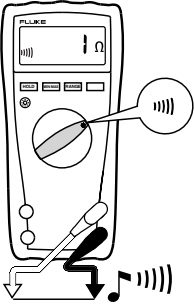

AIK06F.EPS

Testing Diodes

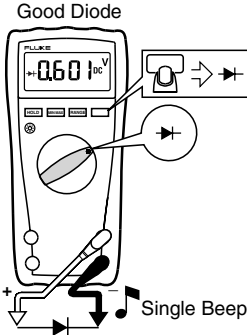

Forward Bias

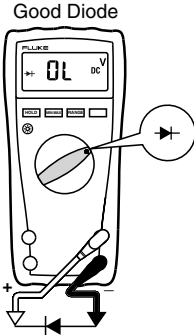

Reverse Bias

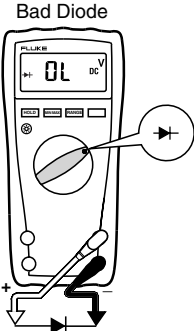

Open

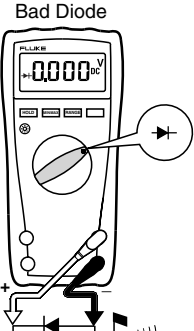

Shorted

AIK07F.EPS

### Measuring AC or DC Current

#### ⚠⚠ Warning

To avoid personal injury or damage to the Meter:

- Never attempt to make an in-circuit current measurement when the open-circuit potential to earth ground is >1000 V.
- Check the Meter's fuses before testing. (See "Testing the Fuses".)
- Use the proper terminals, switch position, and range for your measurement.
- Never place the probes in parallel with a circuit or component when the leads are plugged into the current terminals.

Turn power OFF, break circuit, insert Meter in series, turn power on.

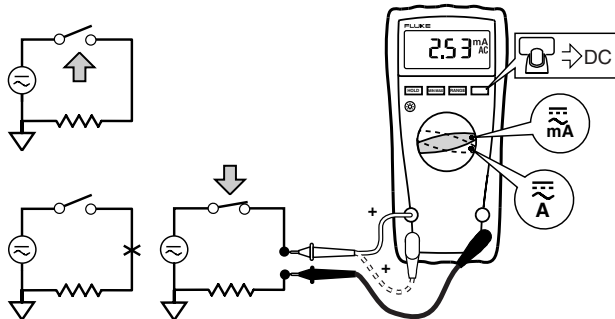

AIK08F.EPS

### Measuring Frequency

#### ⚠⚠ Warning

To avoid electrical shock, disregard the bar graph for frequencies >1 kHz. If the frequency of the measured signal is >1 kHz, the bar graph is unspecified.

The Meter measures the frequency of a signal. The trigger level is 0 V ac for all ranges.

AC Voltage Frequency

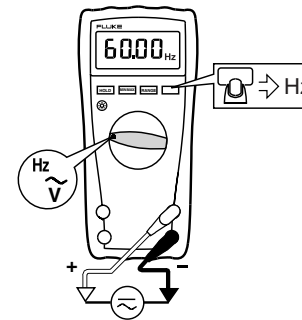

EOM09F.EPS

- ⇒ To exit frequency, press yellow button or turn the rotary switch.
- ⇒ In frequency, the bar graph shows the ac voltage accurately up to 1 kHz.
- ⇒ Select progressively lower ranges using manual ranging for a stable reading.

### Using the Bar Graph

The bar graph is like the needle on an analog Meter. There is an overload indicator (▶) to the right, and a polarity indicator (±) to the left.

Because the bar graph is much faster than the digital display, the bar graph is useful for making peak and null adjustments, and for observing rapidly changing inputs.

The bar graph is disabled when measuring capacitance. In frequency, the bar graph accurately indicates the voltage or current up to 1 kHz.

*The number of lit segments indicates the measured value and is relative to the full-scale value of the selected range.*

For example, in the 60 V range (see below), the major divisions on the scale represent 0, 15, 30, 45, and 60 V. An input of -30 V lights the negative sign and the segments up to the middle of the scale.



AIK11F.EPS

### Cleaning

Wipe the case with a damp cloth and mild detergent. Do not use abrasives or solvents. Dirt or moisture in the terminals can affect readings.

### Testing the Fuses

#### ⚠️ Warning

**To avoid electrical shock or injury, remove the test leads and any input signals before replacing the fuse.**

Test fuses as shown below.

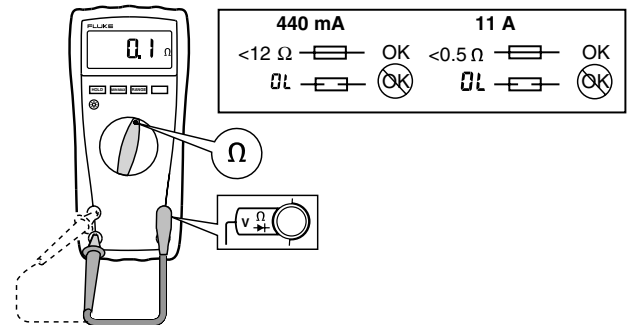

AIK12F.EPS

### **Replacing the Battery and Fuses**

**⚠⚠ Warning**

To avoid shock, injury, or damage to the Meter:

- Use **ONLY** fuses with the amperage, interrupt, voltage, and speed ratings specified. Disconnect test leads before opening case.

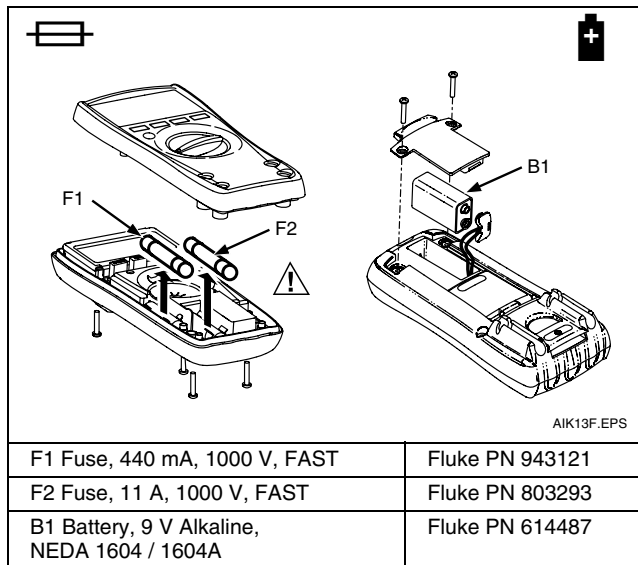

**Specifications**

Accuracy is specified for 1 year after calibration, at operating temperatures of 18 °C to 28 °C, with relative humidity at 0 % to 90 %. Accuracy specifications take the form of the following calculations:

$$\pm ( [ \% \text{ of Reading } ] + [ \text{ Counts } ] )$$

|   |  |
|---|--|
| <b>Maximum voltage between any terminal and earth ground:</b> | 1000   |
| <b>Surge Protection:</b>                                      | 8 kV peak per IEC 61010  |
| <b>⚠ Fuse for mA inputs:</b>                                  | 440 mA, 1000 V FAST Fuse   |
| <b>⚠ Fuse for A input:</b>                                    | 11 A, 1000 V FAST Fuse   |
| <b>Display:</b>   | Digital: 6000 counts, updates 4/sec<br>Bar Graph: 33 segments; updates 32/sec<br>Frequency: 10,000 counts<br>Capacitance: 1,000 counts |
| <b>Altitude:</b>  | Operating: 2000 m; Storage: 12,000 m   |
| <b>Temperature:</b>   | Operating: -10 °C to +50 °C;<br>Storage: -40 °C to +60 °C  |
| <b>Temperature coefficient:</b>                               | 0.1 X (specified accuracy) / °C<br>(<18 °C or >28 °C)  |
| <b>Electromagnetic Compatibility (EN 61326-1:1997):</b>       | In an RF field of 3 V/M, accuracy = specified accuracy.  |
| <b>Relative Humidity:</b>                                     | Maximum, noncondensing<br>90 % to 35 °C<br>75 % to 40 °C;<br>45 % to 50 °C   |
| <b>Battery Life:</b>  | Alkaline: 400 hrs typical  |
| <b>Size (H x W x L):</b>                                      | 4.3 cm x 9 cm x 18.5 cm  |
| <b>Weight:</b>  | 420 g  |
| <b>Safety Compliances:</b>                                    | ANSI/ISA S82.02.01, CSA C22.2-1010.1, IEC 61010 to 1000 V Measurement Category III, 600 V Measurement Category IV                      |
| <b>Certifications:</b>  | CSA, TÜV (EN61010), UL, CE,  , VDE                    |

## Model 77 Series IV

### Users Manual

| Function   | Range  | Resolution   | Accuracy $\pm$ ( [ % of Reading ] + [ Counts ] )  |
|--|--|--|---|
| AC Volts (Average responding)  | 6.000 V<br>60.00 V<br>600.0 V<br>1000 V  | 0.001 V<br>0.01 V<br>0.1 V<br>1 V  | 2.0 % + 2<br>(45 Hz to 1 kHz)   |
| DC mV  | 600.0 mV   | 0.1 mV   | 0.3 % + 1   |
| DC Volts   | 6.000 V<br>60.00 V<br>600.0 V<br>1000 V  | 0.001 V<br>0.01 V<br>0.1 V<br>1 V  | 0.3 % + 1   |
| Continuity   | 600 $\Omega$   | 1 $\Omega$   | Meter beeps at <25 $\Omega$ , beeper turns off at >250 $\Omega$ ; detects opens or shorts of 250 $\mu$ s or longer. |
| Ohms   | 600.0 $\Omega$<br>6.000 k $\Omega$<br>60.00 k $\Omega$<br>600.0 k $\Omega$<br>6.000 M $\Omega$<br>50.00 M $\Omega$ | 0.1 $\Omega$<br>0.001 k $\Omega$<br>0.01 k $\Omega$<br>0.1 k $\Omega$<br>0.001 M $\Omega$<br>0.01 M $\Omega$ | 0.5 % + 2<br>0.5 % + 1<br>0.5 % + 1<br>0.5 % + 1<br>0.5 % + 1<br>2.0 % + 1  |
| Diode test   | 2.400 V  | 0.001 V  | 1 % + 2   |
| Capacitance  | 1000 nF<br>10.00 $\mu$ F<br>100.0 $\mu$ F<br>9999 $\mu$ F <sup>[1]</sup>   | 1 nF<br>0.01 $\mu$ F<br>0.1 $\mu$ F<br>1 $\mu$ F   | 1.2 % + 2<br>1.2 % + 2<br>1.2 % + 2<br>10 % typical   |
| AC Amps (Average responding) <sup>[2]</sup>  | 60.00 mA<br>400.0 mA <sup>[3]</sup><br>6.000 A<br>10.00 A <sup>[4]</sup>   | 0.01 mA<br>0.1 mA<br>0.001 A<br>0.01 A   | 2.5 % + 2<br>(45 Hz to 1 kHz)   |
| <p>[1] In the 9999 <math>\mu</math>F range for measurements to 1000 <math>\mu</math>F, the measurement accuracy is 1.2 % + 2.<br/>           [2] Amps input burden voltage (typical): 400 mA input 2 mV/mA, 10 A input 37 mV/A.<br/>           [3] 400.0 mA accuracy specified up to 600 mA overload.<br/>           [4] &gt;10 A unspecified.</p> |  |  |   |



| Function   | Range   | Resolution                                 | Accuracy $\pm$ ( [ % of Reading ] + [ Counts ] ) |
|--|---|--|--|
| DC Amps <sup>[3]</sup>   | 60.00 mA<br>400.0 mA <sup>[4]</sup><br>6.000 A<br>10.00 A <sup>[5]</sup>  | 0.01 mA<br>0.1 mA<br>0.001 A<br>0.01 A     | 1.5 % + 2  |
| Hz <sup>[1][2]</sup><br>(ac voltage input )  | 99.99 Hz<br>999.9 Hz<br>9.999 kHz<br>99.99 kHz  | 0.01 Hz<br>0.1 Hz<br>0.001 kHz<br>0.01 kHz | 0.1 % + 1  |
| MIN MAX AVG  | For dc functions, accuracy is the specified accuracy of the measurement function $\pm 12$ counts for changes longer than 275 ms in duration.<br>For ac functions, accuracy is the specified accuracy of the measurement function $\pm 40$ counts for changes longer than 1.2 s in duration. |  |  |
| [1] Frequency is specified from 2 Hz to 99.99 kHz.<br>[2] Below 2 Hz, the display shows zero Hz.<br>[3] Amps input burden voltage (typical): 400 mA input 2 mV/mA, 10 A input 37 mV/A.<br>[4] 400.0 mA accuracy specified up to 600 mA overload.<br>[5] >10 A unspecified. |   |  |  |

**Model 77 Series IV**  
Users Manual

| Function   | Overload Protection <sup>[1]</sup> | Input Impedance (Nominal)        | Common Mode Rejection Ratio (1 k $\Omega$ Unbalanced)         |           | Normal Mode Rejection        |
|--|------------------------------------|----------------------------------|---|-----------|------------------------------|
| Volts AC   | 1000 V                             | >10 M $\Omega$ <100 pF           | >60 dB @ dc, 50 Hz or 60 Hz                                   |           |                              |
| Volts DC   | 1000 V                             | >10 M $\Omega$ <100 pF           | >120 dB @ dc, 50 Hz or 60 Hz                                  |           | >60 dB @ 50 Hz or 60 Hz      |
| mV   | 1000 V <sup>[2]</sup>              | >10 M $\Omega$ <100 pF           | >120 dB @ dc, 50 Hz or 60 Hz                                  |           | >60 dB @ 50 Hz or 60 Hz      |
|  |                                    | <b>Open Circuit Test Voltage</b> | <b>Full Scale Voltage To:</b><br>6.0 M $\Omega$ 50 M $\Omega$ |           | <b>Short Circuit Current</b> |
| Ohms/Capacitance   | 1000 V <sup>[2]</sup>              | <8.0 V dc                        | <660 mV dc  | <4.6 V dc | <1.1 mA                      |
| Continuity/Diode test  | 1000 V <sup>[2]</sup>              | <8.0 V dc                        | 2.4 V dc  |           | <1.1 mA                      |
| <p>[1] 10<sup>7</sup> V-Hz maximum.<br/>           [2] For circuits &lt;0.3 A short circuit. 660 V for high energy circuits.</p> |                                    |                                  |   |           |                              |

| Function | Overload Protection             | Overload  |
|----------|---------------------------------|---|
| mA       | Fused, 440 mA, 1000 V FAST Fuse | 600 mA overload for 2 minutes maximum, 10 minutes rest. |
| A        | Fused, 11 A, 1000 V FAST Fuse   | 20 A overload for 30 seconds maximum, 10 minutes rest.  |

# Manual Supplement

Manual Title: 77 Series IV Users  
Part Number: 2695884  
Print Date: September 2006  
Revision/Date:

Supplement Issue: 1  
Issue Date: 10/06  
Page Count: 1

---

---

This supplement contains information necessary to ensure the accuracy of the above manual.

## Change #1 - 38525

On page 4, under **MIN MAX AVG Recording Mode**, under the note replace the last part of both sentences with the following:

*.....changes longer than 350 ms in duration.*

On page 13, under **Function**, replace the MIN MAX AVG, row with the following:

|             |  |
|-------------|--|
| MIN MAX AVG | For dc functions, accuracy is the specified accuracy of the measurement function $\pm 12$ counts for changes longer than 350 ms in duration.<br><br>For ac functions, accuracy is the specified accuracy of the measurement function $\pm 40$ counts for changes longer than 350 ms in duration. |
|-------------|--|

## Change #2

On page 5, under **Manual Ranging and Autoranging**, replace the second paragraph under the note with the following:

*If you press **RANGE** while in MIN MAX\_AVG, the meter beeps twice, indicating an invalid operation, and the range does not change.*

# Model 77 Series IV

Digital Multimeter

## *Calibration Information*

### **Introduction**

#### **⚠⚠ Warning**

**To avoid electric shock or injury, do not perform the performance tests or calibration adjustment procedures unless qualified to do so.**

**The information provided in this document is for the use of qualified personnel only.**

The *Model 77 Series IV Calibration Information* provides the information necessary to adjust and verify the performance of the Fluke Model 77 Series IV Digital Multimeter (hereafter known as the Meter).

The following information is included in this document:

- Safety Information (page 2)
- International Electrical Symbols (page 3)
- Test Lead Alert (page 3)
- Specifications (page 4)
- Testing and Replacing the Fuses (page 7)
- Replacing the Battery (page 8)
- Cleaning (page 9)
- Replacing the LCD (page 9)
- Performance Tests (page 10)
- Calibration Adjustment (page 14)
- Replaceable Parts and Accessories (page 17)
- Complete Warranty (page 19)

See the *Model 77 Series IV Users Manual* for complete operating instructions.

### **Service Information**

To contact Fluke, call one of the following telephone numbers:

USA: 1-888-99-FLUKE (1-888-993-5853)  
Canada: 1-800-36-FLUKE (1-800-363-5853)  
Europe: +31 402-675-200  
Japan: +81-3-3434-0181  
Singapore: +65-738-5655  
Anywhere in the world: +1-425-446-5500

Or, visit Fluke's Web site at [www.fluke.com](http://www.fluke.com).

To register your product, visit [register.fluke.com](http://register.fluke.com)

## **Safety Information**

### **Warning and Caution Statements**

A **⚠⚠ Warning** identifies hazardous conditions and actions that could cause bodily harm or death.

A **⚠ Caution** identifies conditions and actions that could damage the Meter, the equipment under test, or cause permanent loss of data.















#### **⚠⚠ Warnings and Precautions**

To avoid possible electric shock or personal injury, and to avoid possible damage to the Meter or to the equipment under test, adhere to the following practices:

- Use the Meter only as specified in this manual or the protection provided by the Meter might be impaired.
- Do not use the Meter or test leads if they appear damaged, or if the Meter is not operating properly. If in doubt, have the Meter serviced.
- Always use the proper terminals, switch position, and range for measurement.
- Verify the Meter's operation by measuring a known voltage.
- Do not apply more than the rated voltage, as marked on the Meter, between the terminals or between any terminal and earth ground.
- Use caution with voltages above 30 V ac rms, 42 V ac peak, or 60 V dc. These voltages pose a shock hazard.
- Disconnect circuit power and discharge all high-voltage capacitors before testing resistance, continuity, diodes, or capacitance.
- Do not use the Meter around explosive gas or vapor.
- When using the test leads, keep your fingers behind the finger guards.
- Remove test leads from the Meter before opening the Meter case or battery door.

## International Electrical Symbols

The following international symbols appear in this document, and on the Meter.

| Symbols   | Description   | Symbols   | Description   |
|---|---|---|---|
|  | AC (Alternating Current)  |  | Fuse  |
|  | DC (Direct Current)   |  | Conforms to European Union directives   |
|  | DC/AC   |  | Conforms to relevant Canadian Standards Association directives                |
|  | Earth ground  |  | Double-insulated  |
|  | Important Information; see manual.  |  | Hazardous Voltage   |
|  | Battery. (Low battery when shown on display)                                      |  | Underwriters Laboratories, Inc.<br>Meter in accordance with IEC 61010-1. 54CJ |
|  | Inspected and licensed by TÜV (Technischer Überwachungs Verein) Product Services. |  | Conforms to relevant Australian standards                                     |
|  | <i>Verband Deutscher Elektroniker.</i> German electronics association.            |   |   |

## Test Lead Alert

### **Warning**

**Attempting to make a measurement with a test lead in an incorrect terminal might blow a fuse, damage the Meter, and cause serious personal injury.**

As a reminder to check that the test leads are in the correct terminals, **LEAD** is momentarily displayed when the Rotary Switch is moved to or from the **mA** or **A** position.

## Specifications

Accuracy is specified for 1 yr after calibration, at operating temperatures of 18 °C to 28 °C, with relative humidity at 0 % to 90 %. Accuracy specifications take the form of  $\pm([\% \text{ of Reading}] + [\text{Counts}])$ .

### Maximum voltage between any

terminal and earth ground ..... 1000 V

Surge protection ..... 8 kV peak per IEC 61010

⚠ Fuse for mA inputs ..... 440 mA, 1000 V FAST Fuse

⚠ Fuse for A inputs ..... 11 A, 1000 V FAST Fuse

### Display

Digital ..... 6000 counts, updates 4/sec

Bar Graph ..... 33 segments; Updates 32/sec

Frequency ..... 10,000 counts

Capacitance ..... 1,000 counts

### Altitude

Operating ..... 2,000 meters

Storage ..... 12,000 meters

### Temperature

Operating ..... -10 °C to +50 °C

Storage ..... -40 °C to +60 °C

Temperature coefficient ..... 0.1 X (specified accuracy / °C (<18 °C or >28 °C))

### Electromagnetic Compatibility

(EN 61326-1:1997) ..... In an RF field of 3 V/M, accuracy = specified accuracy except in temperature: specified accuracy  $\pm 5$  °C (9 °F)

Relative Humidity (Maximum Non-condensing) 90 % to 35 °C  
75 % to 40 °C;  
45 % to 50 °C

Battery Life ..... 400 hrs typical (Alkaline)

Size (H x W x L) ..... 4.3 cm x 9 cm x 18.5 cm

Weight ..... 420 g

Safety Compliance ..... ANSI/ISA S82.02.01, CSA C22.2-1010.1, IEC 61010 to 1000 V Measurement Category III, 600 V Measurement Category IV

Certifications ..... CSA, TÜV (EN61010), UL, C E,  (N10140), VDE



| Function   | Range  | Resolution  | Accuracy ± ( [ % of Reading ] + [ Counts ] )   |
|--|--|---|--|
| AC Volts (Average responding)  | 6.000 V<br>60.00 V<br>600.0 V<br>1000 V                                  | 0.001 V<br>0.01 V<br>0.1 V<br>1 V                             | 2.0 % + 2<br>(45 Hz to 1 kHz)  |
| DC mV  | 600.0 mV   | 0.1 mV  | 0.3 % + 1  |
| DC Volts   | 6.000 V<br>60.00 V<br>600.0 V<br>1000 V                                  | 0.001 V<br>0.01 V<br>0.1 V<br>1 V                             | 0.3 % + 1  |
| Continuity   | 600 Ω  | 1 Ω   | Meter beeps at <25 Ω, beeper turns off at >250 Ω; detects opens or shorts of 250 μs or longer. |
| Ohms   | 600.0 Ω<br>6.000 kΩ<br>60.00 kΩ<br>600.0 kΩ<br>6.000 MΩ<br>50.00 MΩ      | 0.1 Ω<br>0.001 kΩ<br>0.01 kΩ<br>0.1 kΩ<br>0.001 MΩ<br>0.01 MΩ | 0.5 % + 2<br>0.5 % + 1<br>0.5 % + 1<br>0.5 % + 1<br>0.5 % + 1<br>2.0 % + 1                     |
| Diode test   | 2.400 V  | 0.001 V   | 1 % + 2  |
| Capacitance  | 1000 nF<br>10.00 μF<br>100.0 μF<br>9999 μF <sup>[1]</sup>                | 1 nF<br>0.01 μF<br>0.1 μF<br>1 μF                             | 1.2 % + 2<br>1.2 % + 2<br>1.2 % + 2<br>10 % typical  |
| AC Amps (Average responding) <sup>[2]</sup>  | 60.00 mA<br>400.0 mA <sup>[3]</sup><br>6.000 A<br>10.00 A <sup>[4]</sup> | 0.01 mA<br>0.1 mA<br>0.001 A<br>0.01 A                        | 2.5 % + 2<br>(45 Hz to 1 kHz)  |
| Notes:   |  |   |  |
| [1] In the 9999 μF range for measurements to 1000 μF, the measurement accuracy is 1.2 % + 2. |  |   |  |
| [2] Amps input burden voltage (typical): 400 mA input 2 mV/mA, 10 A input 37 mV/A.           |  |   |  |
| [3] 400.0 mA accuracy specified up to 600 mA overload.                                       |  |   |  |
| [4] >10 A unspecified.   |  |   |  |

| Function   | Range  | Resolution                                 | Accuracy ± ( [ % of Reading ] + [ Counts ] ) |
|--|--|--|--|
| DC Amps <sup>[3]</sup>   | 60.00 mA<br>400.0 mA <sup>[4]</sup><br>6.000 A<br>10.00 A <sup>[5]</sup>   | 0.01 mA<br>0.1 mA<br>0.001 A<br>0.01 A     | 1.5 % + 2                                    |
| Hz <sup>[1], [2]</sup><br>(ac voltage input )                                      | 99.99 Hz<br>999.9 Hz<br>9.999 kHz<br>99.99 kHz   | 0.01 Hz<br>0.1 Hz<br>0.001 kHz<br>0.01 kHz | 0.1 % + 1                                    |
| MIN MAX AVG  | For dc functions, accuracy is the specified accuracy of the measurement function ±12 counts for changes longer than 350 ms in duration.<br>For ac functions, accuracy is the specified accuracy of the measurement function ±40 counts for changes longer than 350 ms in duration. |  |  |
| Notes:   |  |  |  |
| [1] Frequency is specified from 2 Hz to 99.99 kHz.                                 |  |  |  |
| [2] Below 2 Hz, the display shows zero Hz.   |  |  |  |
| [3] Amps input burden voltage (typical): 400 mA input 2 mV/mA, 10 A input 37 mV/A. |  |  |  |
| [4] 400.0 mA accuracy specified up to 600 mA overload.                             |  |  |  |
| [5] >10 A unspecified.   |  |  |  |

**Model 77 Series IV**  
**Calibration Information**

---

| Function   | Overload Protection <sup>[1]</sup> | Input Impedance (Nominal) | Common Mode Rejection Ratio (1 k $\Omega$ Unbalanced) |               | Normal Mode Rejection   |
|--|------------------------------------|---------------------------|---|---------------|-------------------------|
| Volts AC   | 1000 V                             | >10 M $\Omega$ <100 pF    | >60 dB @ dc, 50 Hz or 60 Hz                           |               |                         |
| Volts DC   | 1000 V                             | >10 M $\Omega$ <100 pF    | >120 dB @ dc, 50 Hz or 60 Hz                          |               | >60 dB @ 50 Hz or 60 Hz |
| mV   | 1000 V <sup>2</sup>                | >10 M $\Omega$ <100 pF    | >120 dB @ dc, 50 Hz or 60 Hz                          |               | >60 dB @ 50 Hz or 60 Hz |
|  |                                    | Open Circuit Test Voltage | Full Scale Voltage To:                                |               | Short Circuit Current   |
|  |                                    |                           | 6.0 M $\Omega$  | 50 M $\Omega$ |                         |
| Ohms/Capacitance   | 1000 V <sup>2</sup>                | < 8.0 V dc                | <660 mV dc  | <4.6 V dc     | <1.1 mA                 |
| Continuity/Diode test  | 1000 V <sup>2</sup>                | <8.0 V dc                 | 2.4 V dc  |               | <1.1 mA                 |
| [1] 10 <sup>7</sup> V-Hz maximum.                                      |                                    |                           |   |               |                         |
| [2] For circuits <0.3 A short circuit. 660 V for high energy circuits. |                                    |                           |   |               |                         |

| Function | Overload Protection             | Overload  |
|----------|---------------------------------|---|
| mA       | Fused, 440 mA, 1000 V FAST Fuse | 600 mA overload for 2 minutes maximum, 10 minutes rest. |
| A        | Fused, 11 A, 1000 V FAST Fuse   | 20 A overload for 30 seconds maximum, 10 minutes rest.  |

## Testing the Fuses

### ⚠⚠ Warning

To avoid electrical shock or personal injury:

- Remove the test leads and any input signals before replacing the battery or fuses.
- To avoid electrical shock, arc blast, or damage to the Meter, install only fuses with the amperage, interrupt, voltage, and speed ratings specified in Table 4.

To test the fuses (refer to Figure 1):

1. Set the Rotary Switch to  $\Omega$ .
  2. Plug a test lead into the **V $\Omega$ →** terminal and touch the probe to the **400 mA** to test the 440 mA Fuse or **10 A** terminal to test the 11 A Fuse.
- If the display shows a resistance value in the range shown in Figure 1, the fuse is good.
  - If the display reads **OL**, replace the fuse and test again.
  - If the display shows any other value, have the Meter serviced. See “Service Information” earlier in this manual.

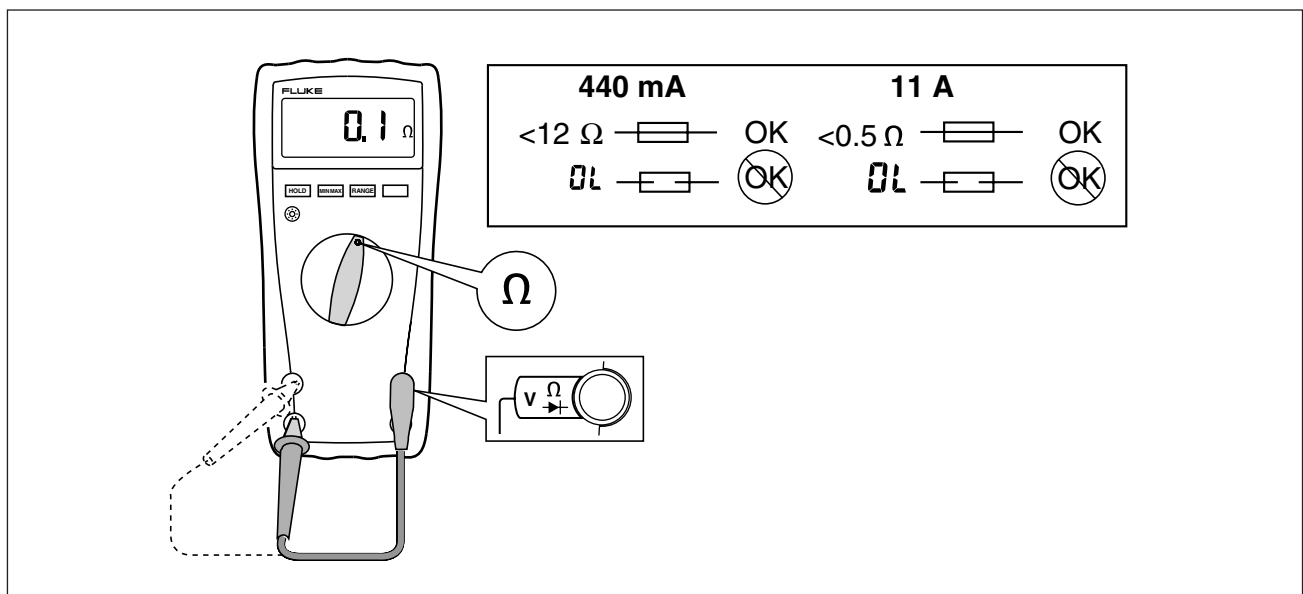

Figure 1. Testing the Current Fuses

aik12f.eps

## Replacing the Fuses

### ⚠ ⚠ Warning

To avoid electrical shock, arc blast, or damage to the Meter, install only fuses with the amperage, interrupt, voltage, and speed ratings specified in Table 4.

To replace the Fuses (refer to Figure 2):

1. Turn the Rotary Switch to **OFF**.
2. Disconnect the test leads and/or any connectors from the terminals.
3. Remove the four screws from the Case Bottom and separate the Case Top from the Case Bottom.
4. Remove the fuses F1 and F2 by gently prying one end loose, then slide the fuse out of its bracket, and replace with exact replacement only.
5. Rejoin the Case Bottom, Case Top, Battery compartment door, and reinstall the four screws.

## Replacing the Battery

To replace the Battery (refer to Figure 2):

1. Turn the Rotary Switch to **OFF** and remove the test leads from the terminals.
2. Remove the two screws from the Battery Compartment Door, and remove it from the Case Bottom.
3. Remove the Battery (B1) from the battery connector.
4. Replace the Battery with a new 9 V battery (NEDA A1604, 6F22, or 006P).
5. Reattach the Battery Compartment Door to the Case Bottom, and reinstall the two screws.

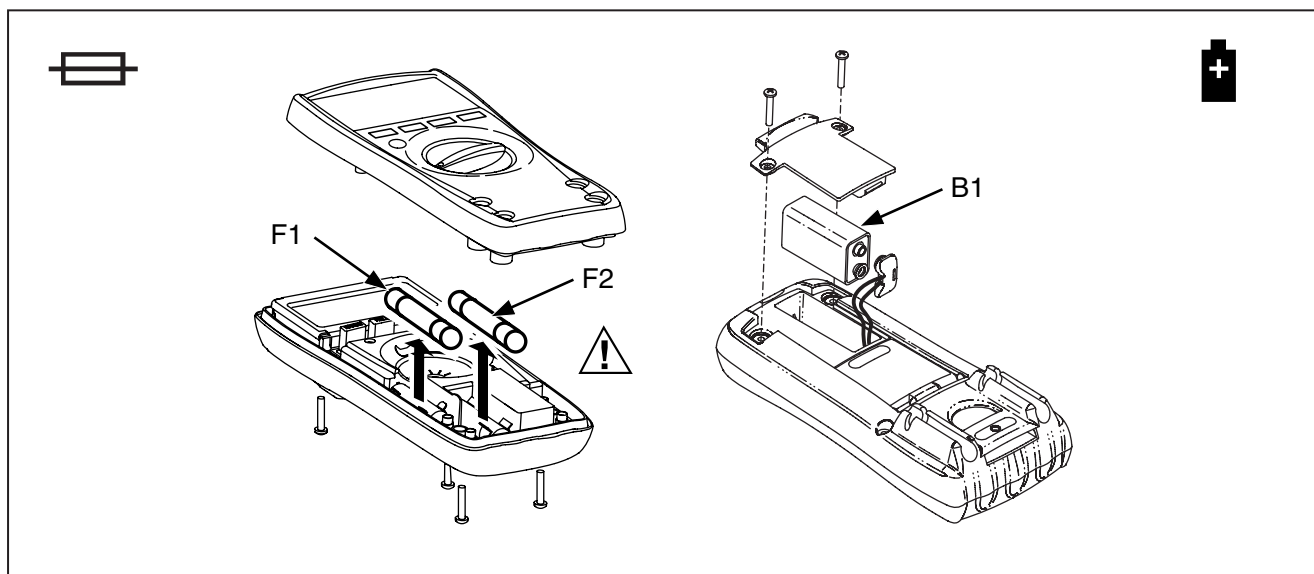

Figure 2. Battery and Fuse Replacement

aik13f.eps

## Cleaning

### ⚠⚠ Warning

To avoid electrical shock:

- Remove test leads and any input signals before cleaning.
- Do not reinstall the pca until it is completely dry.
- Dirt or moisture in the terminals can affect readings.

### ⚠ Caution

To avoid damaging the Meter, do not use aromatic hydrocarbons or chlorinated solvents for cleaning. These solutions will react with the plastics used in the instruments.

Do not use detergents of any kind for cleaning the pca.

Clean the instrument case with a damp cloth and mild detergent.

The pca may be washed with isopropyl alcohol or hot deionized water and a soft brush. Remove excess cleaning material with clean dry air at low pressure, then dry the pca at 50 °C.

## Replacing the LCD

### ⚠ Caution

To prevent contamination, do not handle the conductive edges of the LCD or the LCD Elastomeric Connectors.

If the edges are contaminated, clean them with alcohol. Allow the alcohol to dry before reassembling.

To remove and replace the LCD, perform the following procedure (refer to Figure 3):

1. Turn the rotary switch to **OFF** and remove the test leads from the Meter terminals.
2. Remove the four screws from the case bottom, and separate the case top from the case bottom. The circuit board remains attached to the case bottom.
3. Remove the battery compartment and disconnect the battery from the battery connector.
4. Remove the pca screw located under the 440 mA fuse, and lift the pca out of the case bottom. The beeper is loose in the case. Exercise caution not to damage it.
5. Loosen the four screws in the area of the LCD on the back of the pca. This will facilitate reinstalling the LCD.
6. Insert a small, flat-head screwdriver under the LCD mask edge and gently pry the LCD mask from the snaps.

### ⚠ Caution

Take care to not break the LCD with the screwdriver.

7. Lift out the LCD.
8. Make sure that all connector contact points are clean. Refer to “Cleaning” for more information.
9. Install a new LCD, taking care that it is correctly oriented.
10. Reattach the LCD Mask to the LCD assembly by snapping the LCD mask into place.
11. Tighten the 4 screws on the back of the pca.
12. Lay the pca back into the case bottom, and screw it down.
13. Reinsert the 440 mA Fuse.
14. Reinstall the battery.
15. Rejoin the case bottom, case top, battery compartment door, and reinstall the four case screws.

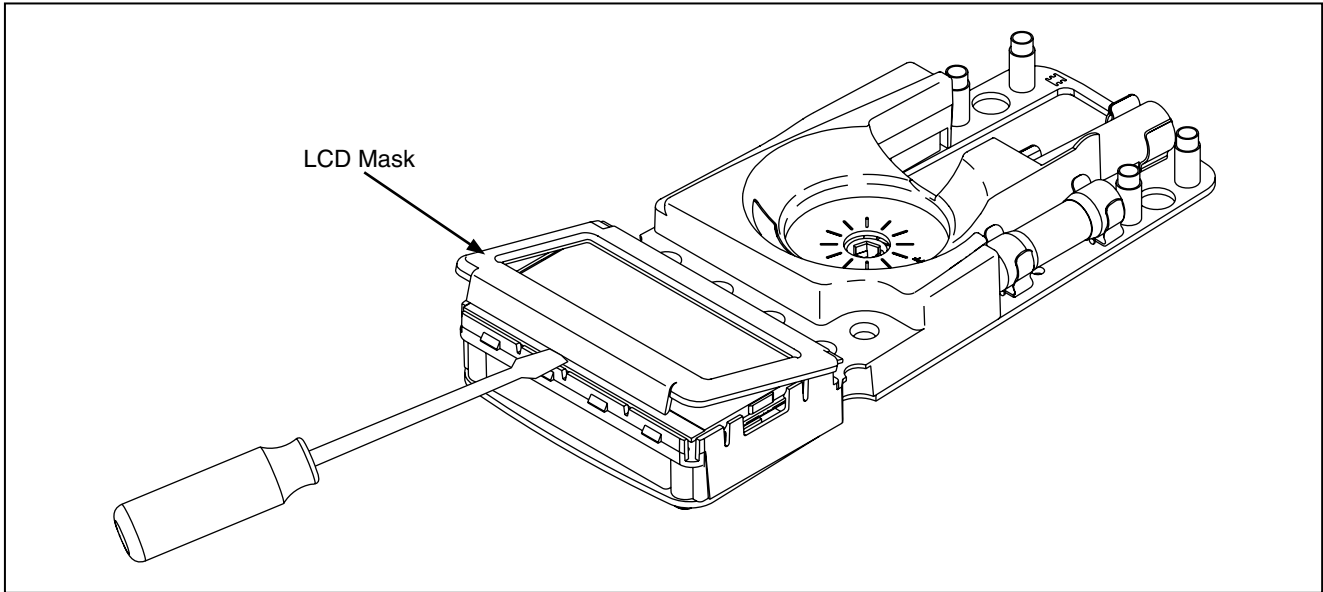

aik15f.eps

**Figure 3. Removing the LCD Mask**

### **Performance Tests**

The following performance tests verify the complete operation of the Meter and check the accuracy of each Meter function against its specifications. The recommended calibration interval is 12 months. If the Meter fails any part of the test, calibration adjustment and/or repair is indicated.

In the performance tests, the Meter is referred to as the unit under test (UUT).

### Required Equipment

A Fluke 5500A Multi-Product Calibrator (or equivalent) is required for the performance test procedures in this document.

If an equivalent calibrator is used, it must meet the accuracy specifications shown in Table 1.

**Table 1. Calibrator Specifications**

| Recommended Equipment                             | Measurement Function | Minimum required accuracy   |
|---|----------------------|---|
| 5500A Multi-Product Calibrator<br>(or equivalent) | DC Volts             | 30 mV to 1000 V $\pm 0.075\%$   |
|   | DC Current           | 3 mA to 9 A<br>$\pm 0.375\%$  |
|   | AC Volts             | 50 mV to 1000 V $\pm 0.5\%$ @ 45 Hz to 1 kHz  |
|   | AC Current           | 0.5 mA to 9 A<br>$\pm 0.625\%$ @ 45 Hz to 1 kHz   |
|   | Resistance           | 25 $\Omega$ to 5 M $\Omega$<br>$\pm 0.125\%$<br>10 M $\Omega$ to 40 M $\Omega$<br>$\pm 0.5\%$ |
|   | Capacitance          | 900 nF<br>$\pm 0.3\%$   |
|   | Frequency            | 5 V, 50 kHz<br>$\pm 0.025\%$  |

### Preparing for the Performance Test

#### **⚠ ⚠ Warning**

To avoid possible electric shock or personal injury:

- Do not perform the following procedures unless qualified to do so. Some procedures involve the use of high voltages.
- Before handling the test connections, and in between tests, make sure the calibrator is in standby (STBY) mode.
- Do not perform the performance test procedures unless the Meter is fully assembled

To prepare for the performance test:

1. Make sure that you have the required equipment (refer to Table 1).
2. Warm up the calibrator as required by its specifications.
3. Allow the temperature of the UUT to stabilize at room temperature (  $23\text{ }^{\circ}\text{C} \pm 5\text{ }^{\circ}\text{C}$  [ $73\text{ }^{\circ}\text{F} \pm 9\text{ }^{\circ}\text{F}$ ] ).
4. Check the fuses and Battery, and replace them if necessary. Refer to *Testing the Fuses*, *Replacing the Fuses*, and *Replacing the Battery*.

**Performance Tests**

*Note*

When calibrating or measuring ac current, avoid the potential for errors from coupled noise by either:

1. Shorting the  $V\Omega \rightarrow$  to the COM input  
or
  2. Having **no** connection to the  $V\Omega \rightarrow$  input.
1. Set the Meter's Rotary Switch to the position called for in Table 2, and for all measurements other than current (amps), connect the calibrator to the  $V\Omega \rightarrow$  and **COM** input terminals.
    - If testing the milliamps function, connect the calibrator to the Meter **400 mA** and **COM** input terminals.
    - If testing the amps function, connect the calibrator to the Meter **10A** and **COM** input terminals.
  2. Referring to Table 2 or Table 3, apply the indicated calibrator output voltages to the UUT for each test.
  3. Verify that the UUT displays a reading that is within the limits shown in the Meter Response column.

**Table 2. Performance Tests**

| Steps | Test<br>(Switch Position)       | 5500 Output   | Meter Response   |                  |
|-------|---------------------------------|---|------------------|------------------|
|       |                                 |   | Lower Limit      | Upper Limit      |
| 1     | $\Omega$<br>Ohms <sup>[2]</sup> | 500 $\Omega$  | 497.3 $\Omega$   | 502.7 $\Omega$   |
| 2     |                                 | 50 k $\Omega$                                       | 49.74 k $\Omega$ | 50.26 k $\Omega$ |
| 3     |                                 | 5 M $\Omega$  | 4.974 M $\Omega$ | 5.026 M $\Omega$ |
| 4     |                                 | 10 M $\Omega$                                       | 9.79 M $\Omega$  | 10.21 M $\Omega$ |
| 5     |                                 | 40 M $\Omega$                                       | 39.19 M $\Omega$ | 40.81 M $\Omega$ |
| 6     | )))<br>Continuity               | 25 $\Omega$   | Beeper On        |                  |
| 7     |                                 | 250 $\Omega$  | Beeper Off       |                  |
| 8     | $\tilde{V}$<br>AC Volts         | 50 mV 45 Hz   | 0.47 V ac        | 0.53 V ac        |
| 9     |                                 | 5 V 45 Hz   | 4.898 V ac       | 5.102 V ac       |
| 10    |                                 | 5 V 1 kHz   | 4.898 V ac       | 5.102 V ac       |
| 11    |                                 | 50 V 45 Hz  | 48.98 V ac       | 51.02 V ac       |
| 12    |                                 | 50 V 1 kHz  | 48.98 V ac       | 51.02 V ac       |
| 13    |                                 | 500 V 45 Hz   | 489.8 V ac       | 510.2 V ac       |
| 14    |                                 | 500 V 1 kHz   | 489.8 V ac       | 510.2 V ac       |
| 15    |                                 | 1000 V 45 Hz  | 978 V ac         | 1022 V ac        |
| 16    |                                 | 1000 V 1 kHz  | 978 V ac         | 1022 V ac        |
| 17    |                                 | $\tilde{V}$ Hz<br>AC Volts Frequency <sup>[1]</sup> | 5 V 50 kHz       | 49.94 kHz        |



**Table 2. Performance Tests (cont)**

| Steps | Test<br>(Switch Position)                | 5500 Output  | Meter Response |              |
|-------|--|--------------|----------------|--------------|
|       |  |              | Lower Limit    | Upper Limit  |
| 18    | <b>V</b><br>DC Volts                     | 5 V          | 4.984 V dc     | 5.016 V dc   |
| 19    |  | 300 V        | 299.0 V dc     | 301.0 V dc   |
| 20    |  | 1000 V       | 996 V dc       | 1004 V dc    |
| 21    |  | -1000 V      | -1004 V dc     | -996 V dc    |
| 22    | <b>mV</b><br>DC Millivolts               | 30 mV        | 29.8 mV dc     | 30.2 mV dc   |
| 23    |  | -300 mV      | -301.0 mV dc   | -299.0 mV dc |
| 24    |  | 600 mV       | 598.1 mV dc    | 601.9 mV dc  |
| 25    | <b>⊕</b><br>Capacitance <sup>[1]</sup>   | Apply 900 nF | 887 nF         | 913 nF       |
| 26    | <b>→</b><br>Diode Test <sup>[1]</sup>    | 0.5 mA 45 Hz | 0.47 mA ac     | 0.53 mA ac   |
| 27    |  | 50 mA 1 kHz  | 48.73 mA ac    | 51.27 mA ac  |
| 28    | <b>mA</b><br>AC Milliamps                | 400 mA 1 kHz | 389.8 mA ac    | 410.2 mA ac  |
| 29    | <b>A</b><br>AC Amps                      | 4.0 A 45 Hz  | 3.898 A ac     | 4.102 A ac   |
| 30    |  | 9.0 A 1 kHz  | 8.75 A ac      | 9.25 A ac    |
| 31    | <b>mA</b><br>DC Milliamps <sup>[1]</sup> | 3 mA, 0 Hz   | 2.93 mA dc     | 3.07 mA dc   |
| 32    |  | 50 mA        | 49.23 mA dc    | 50.77 mA dc  |
| 33    |  | -400 mA      | -406.2 mA dc   | -393.8 mA dc |
| 34    | <b>A</b><br>DC Amps <sup>1</sup>         | 4.0 A        | 3.938 A dc     | 4.062 A dc   |
| 35    |  | -9.0 A       | -9.16 A dc     | -8.84 A dc   |

1. Press the YELLOW button to access this function.  
2. Does not include test lead resistance.

## Calibration Adjustment

Perform the calibration adjustment procedures if the Meter fails the performance tests.

The Meter buttons behave as follows when the calibration mode is enabled:

- |        |  |
|--------|--|
| HOLD   | Press and hold this button to test the present function. This measurement is uncalibrated and may be inaccurate. This is normal.   |
| MINMAX | Press and hold this button to display the required input.  |
|        | Press this YELLOW button to store the calibration value and advance to the next step. This button is also used to exit calibration mode after the calibration adjustment sequence is complete. |

## Calibration Adjustment Procedure

Use the following steps to adjust the Meter's calibration:

Switch the Meter to  $\overline{\text{mV}}$  DC.

1. Turn the Meter over and find the Calibration Seal located near the top of the Meter (refer to Figure 4).
2. With a small probe, break the Calibration Seal and press the Calibration Button for 1 second. The Meter will beep and change to the calibration mode. The display reads  $\text{[-0]}$ , designating the first calibration step. The Meter remains in calibration mode until the Rotary Function Switch is turned off.
3. Proceed through the calibration steps by entering the input value listed in the table for each step.

### Note

*When calibrating or measuring ac current, avoid the potential for errors from coupled noise by either:*

1. *Shorting the  $\text{V}\Omega\rightarrow$  to the COM input*
- or
2. *Having NO connection to the  $\text{V}\Omega\rightarrow$  input.*

### Note

*After pressing the yellow button, wait until the step number advances before changing the calibrator source or turning the Rotary Switch.*

4. After each input value is applied, press the yellow button to accept the value and proceed to the next step ( $\text{[-0]}$  and so forth).
5. When the last step in a function is reached, turn the Rotary Function Knob to the next required function. The Meter will not allow a step to be completed if the Rotary Function Knob is turned to the wrong function.

### Note

*If the calibration adjustment procedure is not completed correctly, the Meter will not operate correctly. When calibration adjustment is not performed correctly, the Meter displays the messages  $\text{[AL]}$  and  $\text{[Err]}$  and the Meter must be recalibrated.*

*The Meter is damaged and requires service if:*

- $\text{[AL]}$  and  $\text{[Err]}$  messages continue to appear after a proper recalibration.
- $\text{[EEPr]}$  and  $\text{[Err]}$  messages are alternating on the display.
- $\text{[EEPr]}$  message appears on the display.

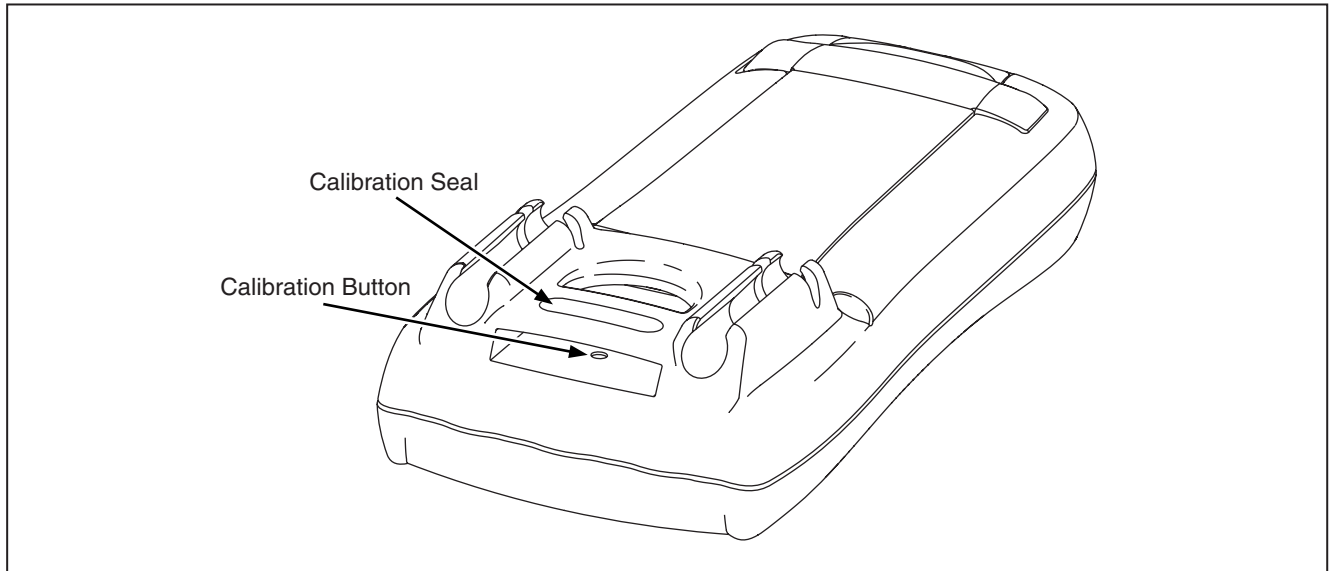

**Figure 4. Calibration Access**

aik14f.eps

**Table 3. Calibration Steps**

| Function<br>(Switch Position)             | Calibration Step | Input Value        |
|---|------------------|--------------------|
| $\overline{\text{mV}}$<br>(DC Millivolts) | [-01]            | 600.0 mV dc        |
|   | [-02]            | 120.0 mV dc        |
| $\overline{\text{V}}$<br>(DC Volts)       | [-03]            | 6.000 V dc         |
|   | [-04]            | 60.00 V dc         |
|   | [-05]            | 600.0 V dc         |
| $\tilde{\text{V}}$<br>(AC Volts)          | [-06]            | 600.0 mV, 60 Hz    |
|   | [-07]            | 600.0 V, 60 Hz     |
| $\Omega$<br>(Ohms)                        | [-08]            | 600.0 $\Omega$     |
|   | [-09]            | 6.000 k $\Omega$   |
|   | [-10]            | 60.00 k $\Omega$   |
|   | [-11]            | 600.0 k $\Omega$   |
|   | [-12]            | 6.000 M $\Omega$   |
| $\rightarrow $<br>(Diode Test)            | [-13]            | 5.000 V dc         |
| <b>mA</b><br>(Milliamps)                  | [-14]            | 400.0 mA dc        |
|   | [-15]            | 400.0 mA ac, 60 Hz |
| <b>A</b><br>(Amps)                        | [-16]            | 6.000 A dc         |
|   | [-17]            | 6.000 A ac, 60 Hz  |

\* If the Meter is not connected correctly, or if the rotary switch is in the wrong position, the Meter will beep 2 times to alert the user.

## Replaceable Parts and Accessories

Replaceable parts and accessories are shown in Table 4 and Figure 5.

### ⚠⚠ Warning

**To avoid electric shock, injury, or damage to the meter, use exact replacement parts only.**

**Table 4. Replaceable Parts**

| Item | Description  | Part No | Qty |
|------|--|---------|-----|
| --   | (Not shown) TL75 Test Lead Set*  | 855705  | 1   |
| --   | (Not Shown)<br>77 Series IV Users Manual (English only)                    | 2695884 | 1   |
|      | 77 Series IV Users Manual CD (English, and all translated versions)        | 2695825 | 1   |
| 1    | Case Top   | 2695766 | 1   |
| 2    | Window   | 648714  | 1   |
| 3    | Shock Absorber   | 428441  | 1   |
| 4    | Keypad   | 1560052 | 1   |
| 5    | LCD Mask   | 2695775 | 1   |
| 6    | LCD  | 1560856 | 1   |
| 7    | LCD Light Pipe   | 1564806 | 1   |
| 8    | ⚠ Fuse, 11 A, (fast acting), 1000 V ac/dc, minimum interrupt rating 17 kA  | 803293  | 1   |
| 9    | ⚠ Fuse, 440 mA (fast acting), 1000 V ac/dc, minimum interrupt rating 10 kA | 943121  | 1   |
| 10   | PCA Screw  | 1626602 | 1   |
| 11   | AC Shield  | 648755  | 1   |
| 12   | AC Shield and Internal Cover screws  | 448456  | 5   |
| 13   | Case Bottom (includes bottom shield and calibration button)                | 2095692 | 1   |
| 14   | Battery, 9 V (Alkaline, 9 V, 0-200 mA)                                     | 614487  | 1   |
| 15   | Battery Compartment Door   | 1564799 | 1   |
| 16   | Case Screws  | 832246  | 4   |
| 17   | Tilt Stand   | 648961  | 1   |
| 18   | LCD Elastomeric Connector  | 650264  | 2   |
| 19   | Internal Cover   | 1564786 | 1   |
| 20   | Battery Connector  | 1988201 | 1   |
| 21   | Beeper   | 2041050 | 1   |
| 22   | Switch Detent Spring   | 822643  | 1   |
| 23   | Switch Knob  | 648706  | 1   |
| 24   | Calibration Button   | 1564889 | 1   |

\* Fluke accessories are available from your authorized Fluke distributor.

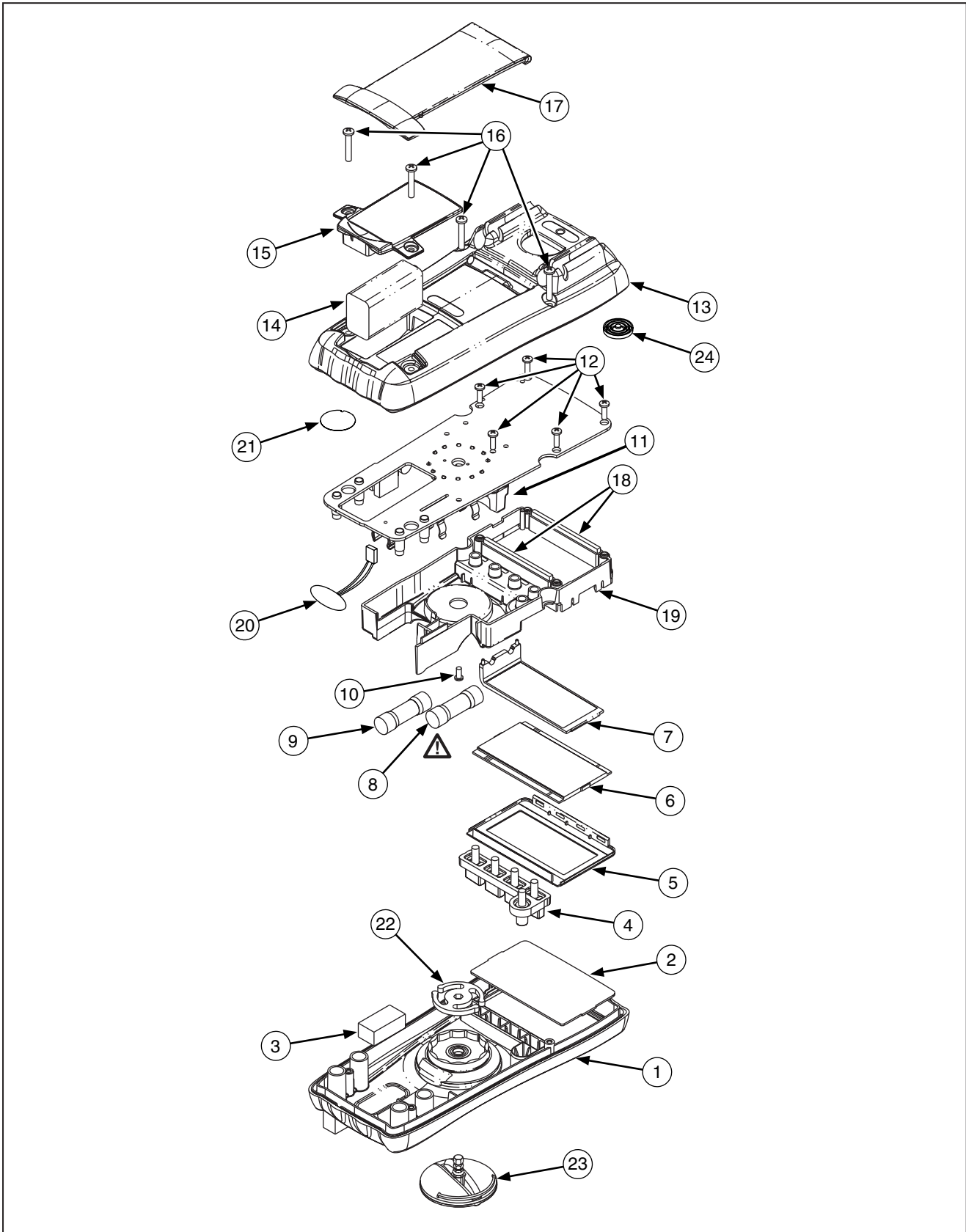

**Figure 5. Replaceable Parts and Accessories**

aik16f.eps

**Lifetime Limited Warranty**

Each Fluke 20, 70, 80, 170, and 180 Series DMM will be free from defects in material and workmanship for its lifetime. As used herein, "lifetime" is defined as seven years after Fluke discontinues manufacturing the product, but the warranty period shall be at least ten years from the date of purchase. This warranty does not cover fuses, disposable batteries, damage from neglect, misuse, contamination, alteration, accident or abnormal conditions of operation or handling, including failures caused by use outside of the product's specifications, or normal wear and tear of mechanical components. This warranty covers the original purchaser only and is not transferable.

For ten years from the date of purchase, this warranty also covers the LCD. Thereafter, for the lifetime of the DMM, Fluke will replace the LCD for a fee based on then current component acquisition costs.

To establish original ownership and prove date of purchase, please complete and return the registration card accompanying the product, or register your product on <http://www.fluke.com>. Fluke will, at its option, repair at no charge, replace or refund the purchase price of a defective product purchased through a Fluke authorized sales outlet and at the applicable international price. Fluke reserves the right to charge for importation costs of repair/replacement parts if the product purchased in one country is sent for repair elsewhere.

If the product is defective, contact your nearest Fluke authorized service center to obtain return authorization information, then send the product to that service center, with a description of the difficulty, postage and insurance prepaid (FOB Destination). Fluke assumes no risk for damage in transit. Fluke will pay return transportation for product repaired or replaced in-warranty. Before making any non-warranty repair, Fluke will estimate cost and obtain authorization, then invoice you for repair and return transportation.

**THIS WARRANTY IS YOUR ONLY REMEDY. NO OTHER WARRANTIES, SUCH AS FITNESS FOR A PARTICULAR PURPOSE, ARE EXPRESSED OR IMPLIED. FLUKE SHALL NOT BE LIABLE FOR ANY SPECIAL, INDIRECT, INCIDENTAL OR CONSEQUENTIAL DAMAGES OR LOSSES, INCLUDING LOSS OF DATA, ARISING FROM ANY CAUSE OR THEORY. AUTHORIZED RESELLERS ARE NOT AUTHORIZED TO EXTEND ANY DIFFERENT WARRANTY ON FLUKE'S BEHALF.** Since some states do not allow the exclusion or limitation of an implied warranty or of incidental or consequential damages, this limitation of liability may not apply to you. If any provision of this warranty is held invalid or unenforceable by a court or other decision-maker of competent jurisdiction, such holding will not affect the validity or enforceability of any other provision.

Fluke Corporation  
P.O. Box 9090  
Everett, WA 98206-9090  
U.S.A.

Fluke Europe B.V.  
P.O. Box 1186  
5602 BD Eindhoven  
The Netherlands





# Manual Supplement

|                |                          |                   |      |
|----------------|--------------------------|-------------------|------|
| Manual Title:  | 77 Series IV Calibration | Supplement Issue: | 1    |
| Print Date:    | September 2006           | Issue Date:       | 3/07 |
| Revision/Date: |                          | Page Count:       | 1    |

---

---

This supplement contains information necessary to ensure the accuracy of the above manual. Enter the corrections in the manual if either one of the following conditions exist:

1. The revision letter stamped on the indicated PCA is equal to or higher than that given with each change.
2. No revision letter is indicated at the beginning of the change.

## Change #1

On page 12, Table 2, under **Meter Response** Beeper Off, change step 8,

From:

|           |           |
|-----------|-----------|
| 0.47 V ac | 0.53 V ac |
|-----------|-----------|

To:

|            |            |
|------------|------------|
| 0.047 V ac | 0.053 V ac |
|------------|------------|

## Change #2

On page 13, Table 2, make the following changes:

Under **5500 Output**, step 25 change:

From:

|              |
|--------------|
| Apply 900 nF |
|--------------|

To:

|        |
|--------|
| 900 nF |
|--------|

Add a new step 26 and renumber the remaining steps accordingly:

|    |                             |       |            |            |
|----|-----------------------------|-------|------------|------------|
| 26 | ➔ Diode Test <sup>[1]</sup> | 2.0 V | 1.978 V dc | 2.022 V dc |
|----|-----------------------------|-------|------------|------------|